

EPSFA-50-A

Folha de dados

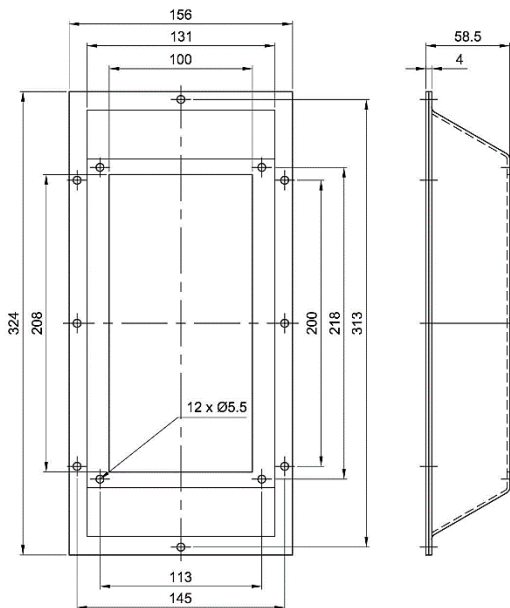

Dimensões:



Dados técnicos:

Peso	0,8 kg
Faixa de temperatura operacional	-40 .. +120 °C
Adequado para o dispositivo	EPMS-50-A
Certificados	CE

